

- Use a small pin fit to size to insert into positioning setting keyhole at rear side of remote and press it to make the light on. Then press "down" key on remote to operate screen to go down. When screen moves to the required position, then press "stop" button. And please press positioning setting keyhole with pin again. This is the down positioning set as required. Please follow the same to set up limit, Please check below:

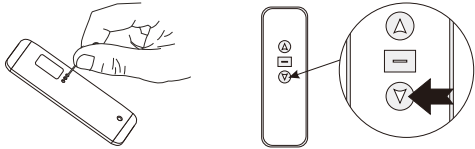

Note: Maximum travel distance of steel wire is 5 meters.

C. LVC:

Simply contact RJ12 6P6C connector. From left to right, 3-6 is control signal cable, 3 is common cable, 4 is stop, 5 is lower, 6 is lift.

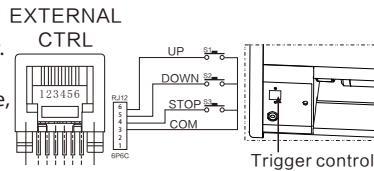

D. RS485 or RS232 :

From left to right, 1 & 2 cable for control. For RS485, cable 1 is D-, cable 2 is D+. The connecting of RS232 as figure shows.

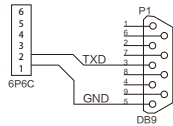

RS485/RS232 control protocol:

- Baud Rate: 2400
 - Data Bits: 8
 - Stop Bits: 1
 - Parity: None
- Hex command:
- Screen UP: ff ee ee ee dd
 - Stop: ff ee ee ee cc
 - Down: ff ee ee ee ee

In some cases you may need to enable the RS-232 control by sending hex command: ff ee ee ee aa

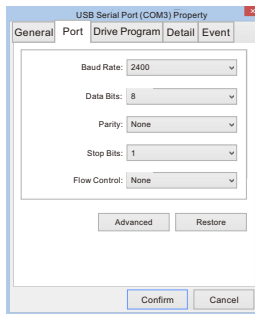

Note:

- When setting RS232 or RS485, if the screen is not able to operate as it is, please switch position of No. 1 and No. 2.
- The electric resistance of return circuit is less than 20Ω.
- Do not do wiring nearby interference sources.

Setting for Up and Down Limited Positioning for Motor:

- The limited positioning of motor has been defaulted when EX-factory, it is not allowed to reset.

Screen: Voltage AC220-230V/50-60HZ, 0.8Amp, power 190watts.
RF remote(F): Voltage 3V, use CR2450*1 battery.
Radio Frequency: 433Hz. maximum control distance 15m.

Liberty Grandview®

Liberty Grandview®

Protecting your Screen:

To ensure long lasting viewing enjoyment keep the screen rolled up when not in use. Check both the front and back surfaces before retracting into the case to make sure it is free of dust, dirt, insects or other foreign matter. Use a soft brush or cloth to lightly remove any foreign particles.

Cleaning your Screen:

Use warm water with a mild detergent to remove any marks on the surface or screen casing (only dab, do not rub). Immediately dry the screen with a soft cloth or towel. Do not leave it to air dry.

Never use any solvents, chemicals or abrasive cleaners on the screen surface as they can permanently damage the screen surface.

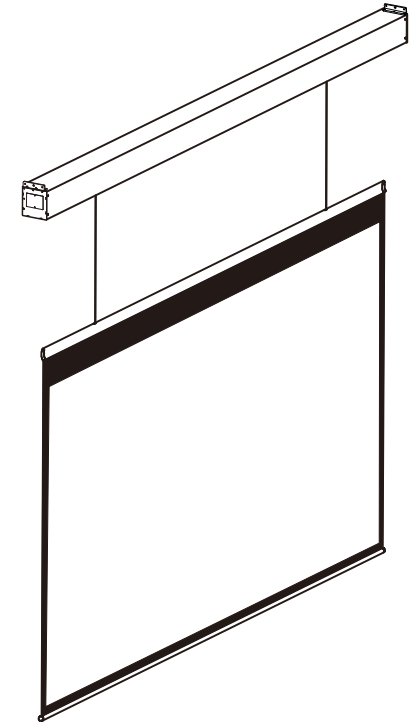

User Manual for SkyShow Series Model D

Integrated Motorized Screen
Suitable for Model Named SK-MI(F)

AAV-VISION EQUIPMENTS (INDIA) (P) LTD.

Mktg. Off: 1-20-248, 2nd Floor, (Snowcem Paints Lane),
Rasoolpura, Secunderabad-500 003, A.P., INDIA.
Tel : +91(0)40-2781 5419 / 2781 4350 / 2789 0599 / 2781 8419 / 20 / 21
Fax : +91(0)40-2781 5399 (Off.) / 2781 4612 (Mktg)
Mobile: + 91- (0) 99590 24099 / 98490 24099
E-mail : sales@av-visionindia.co.in
Website : www.av-visionindia.co.in

Grandview Crystal Screen Canada Ltd.

#11- 3751 North Fraser Way,
Marine Way Business Centre,
Burnaby, BC, Canada V5J 5G4
Tel: 1-604-412-9777 Fax: 1-604-412-9796
Website: www.grandviewscreen.ca

Guangzhou Grandview Crystal Screen Co., Ltd.

No. 43 South International Trade Avenue, Hualong Town,
Panyu, Guangzhou, Guangdong, China
Tel: +8620-8489-9499 Fax: +8620-8480-3343
Website: www.grandviewscreen.com
www.grandviewscreen.com.cn

Dear Customers:

Thank you for the purchasing of Grandview Skyshow series D-type projection screen. Before your normal using of product, please read the specification first, and keep it well for future

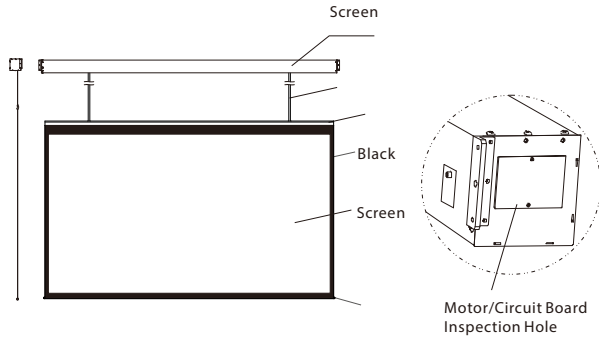

Accessories:

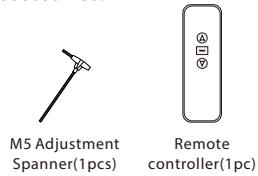

CAUTION

In order to ensure product safety during transportation, we install fixing screws at the two ends of product. Fixing screws must be taken out before screen installation,

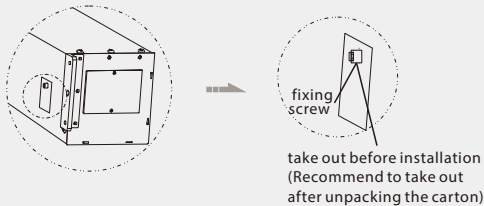

WARNING: Please guarantee ceiling or wall or suspension device can bearing 4 times of product net weight before installation, otherwise people hurt and property losses possible to happen by the reason of screen falling.

WARNING: Installation position must strictly fit for the dimension of product, to avoid problems like product cannot be installed or install leaning.

- Please prepare below necessary Installation tools: Screws driver, leveling Instrument, tape measure and marker.
- Before installation, please measure the installation screws
- It must be assured the screen is fixed firmly onto the wall which is strong enough according to the size and self weight.
- After installation, keep the casing both edge level.

- It is recommended to use hook available with adjustable length, please check below:

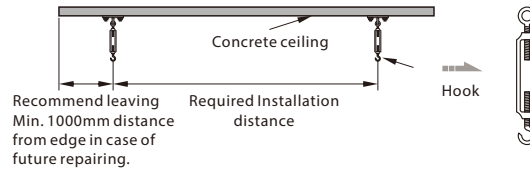

- Make sure the hook is well fixed onto the ceiling, hang the screen on and lock the buckle. Ensure the hook and buckle is well installed in case of dropping accidentally, figure below:

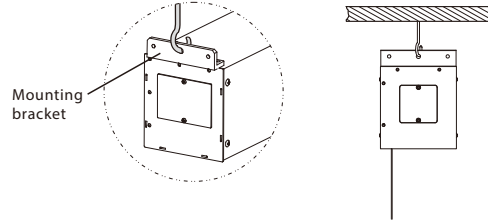

- Leave at least 1000mm spare distance on the left edge referring to ceiling hanging installation. Fix the left and right mounting brackets with screws onto wall and make it firm.

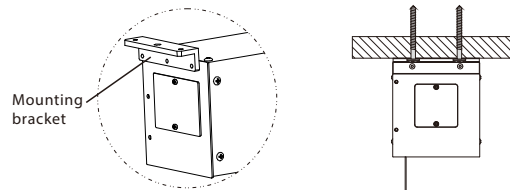

- Leave at least 1000mm spare distance on the left edge referring to ceiling hanging/ ceiling mounted installation. Fix the left and right mounting brackets with screws onto wall

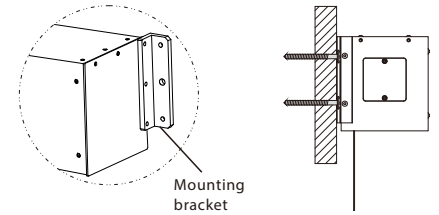

Caution:

Please remove all the stickers before operate the screen.

Important note:

This product is using Single-phase AC power supply, must well

Power connection:

Grandview screen is pre-install with your local plug, you can

Fabric control instruction

4 Control ways are available for integrated

- Manual control (cyclic key)
- Wireless remote
- LVC

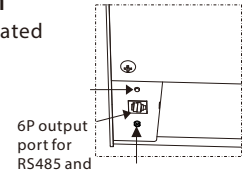

A. Manual control:

Manual control button is on the left side of the casing (close to RS485 and dry contact interface), this is a cycle control button.

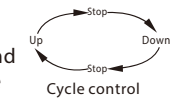

B. RF remote with model name :

- Press Up button, screen retract
- Press Stop button, screen stop
- Press Down button, screen expand
- RF remote is pre-setting in factory with the screen, also can reset if necessary.

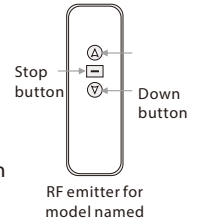

Remote pairing:

It's the remote pairing status once motor connect to the power within 10 seconds. Press UP & STOP button together for remote pairing with

Remote un-pairing:

It's the remote pairing status once motor connect to the power within 10 seconds. Press UP & STOP button together for clear the memory,

Electronic positioning by Remote

- User could set the down limit with remote according to requirement.